

# VERIZON APPROVED TROMPETER PRODUCTS FOR DS3 APPLICATIONS

Verizon Approved Trompeter Products For DS3 Applications (NP-IL-2001-107)

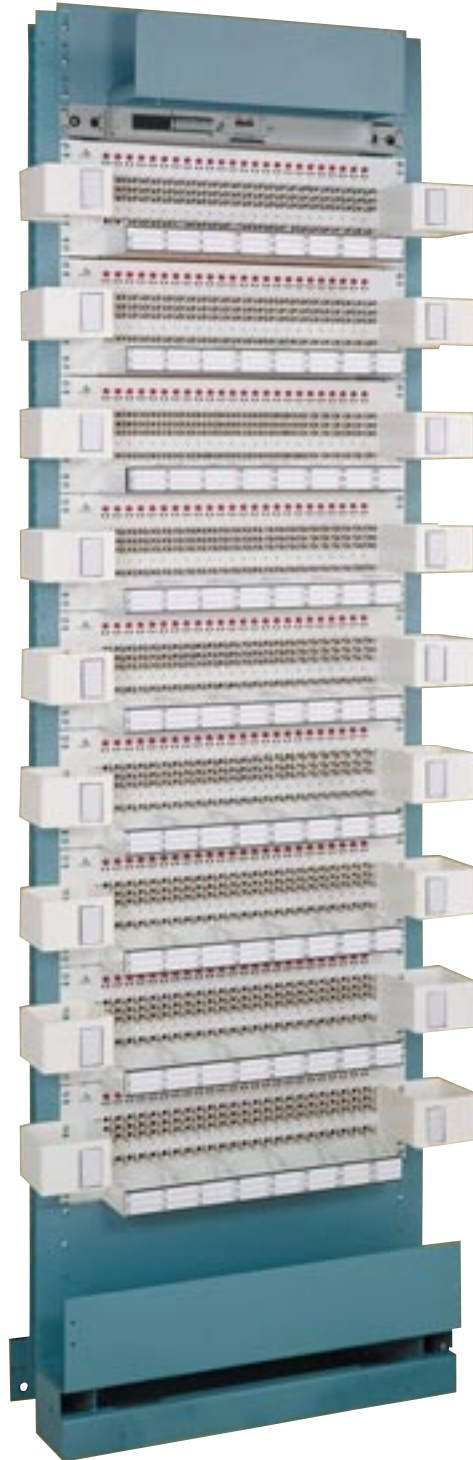

# DS3



# VERIZON APPROVED TROMPETER PRODUCTS FOR DS3 APPLICATIONS



Verizon Approved Trompeter Products For DS3 Applications (NP-IL-2001-107)

## INTRODUCTION

Trompeter Electronics, founded in 1960, is a designer/manufacturer of point of termination equipment, connectors, and cross connects for the DS3 coaxial wireline in the telco central office. The company is ISO 9001 registered and enjoys an international presence in the Telecommunications Industry. Most Trompeter telco products are NEBS tested and approved.

## ISO 9001 REGISTRATION

Trompeter has been ISO 9001 since 1994. The main value of being an ISO 9001 registered company is in the assurance to our customers that we have a solid quality system in place, and that it is well documented. DET Norske Veritas (DNV), our ISO Registrar, has certified that we are in compliance with established systems and policies. ISO 9001 Quality System Standard is a document outlining twenty elements of quality that Trompeter addressed in order to meet registration requirements. An accredited ISO 9001 auditor must verify, through on-site audits, that a company has a well documented quality system in place that meets the requirements of ISO 9001, and that the company is working in accordance with the documented system. Trompeter's Quality System is also certified by numerous other accredited agencies. ISO 9001 registration makes Trompeter more competitive in the global market by giving customers the assurance that they are dealing with a company dedicated to meeting their quality expectations.



**NEBS LEVEL 3 TYPE 2 COMPLIANT AND TEST CERTIFIED**



## NEBS LEVEL 3 TYPE 2 COMPLIANT AND TEST CERTIFIED

NEBS stands for the Network Equipment-Building Systems and has several levels and types. The most stringent level is Level 3 and the type that involves the central office DS3 coaxial transmission line is Type 2. The Bellcore specifications that define this testing are contained in GR-63-CORE, Issue 1, October 1995 and GR-1089-CORE, Issue 2, Revision 1, December 1999.

The NEBS standard is now in place as a condition of selling equipment into the public network, particularly the central office, where high reliability is so key to uninterrupted service levels for data and digitized voice.

A partial list of the testing includes airborne particulates, earthquake vibration, low temperature exposure, open flame, high relative humidity, altitude, heat dissipation, fire propagation, mixed flow gas airborne contaminates, acoustic noise emissions, office and shipping vibration and drop, and illumination clarity in addition to all the stringent electrical and data rate signal requirements.

The Trompeter BNC connector is NEBS Level 3 Type 2 approved for the central office DS3 line. NEBS compliance is a requirement of the Verizon central office.



THIS PRODUCT IS TESTED AND CERTIFIED BY NTS (NATIONAL TECHNICAL SYSTEMS) TO BE COMPLIANT TO **NEBS** (NETWORK EQUIPMENT-BUILDING SYSTEMS) **LEVEL 3 TYPE 2** PER BELLCORE GR-63-CORE AND GR-1089-CORE PER TEST REPORTS 074-0206A AND 070-0206B.

Trompeter Electronics / 31186 La Baya Drive / Westlake Village, CA 91362 [www.trompeter.com](http://www.trompeter.com)



# Front Coaxial DSX Cross Connect Bays, Panels & Modules

Verizon Approved Trompeter Products For DS3 Applications (NP-IL-2001-107)



**NEBS LEVEL 3 TYPE 2 COMPLIANT  
AND TEST CERTIFIED**

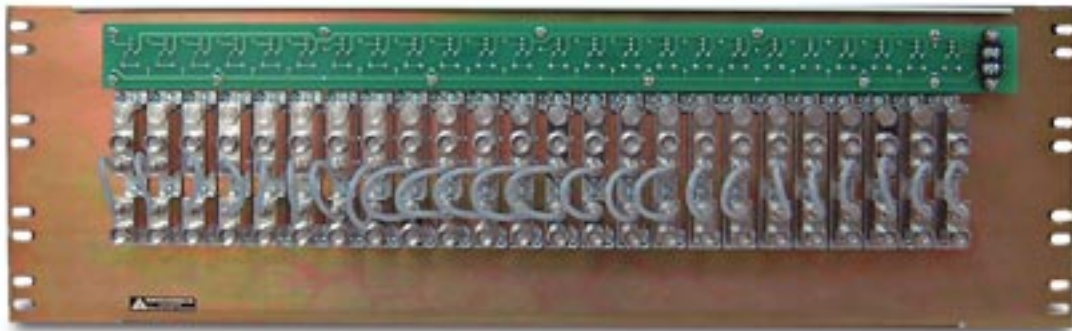
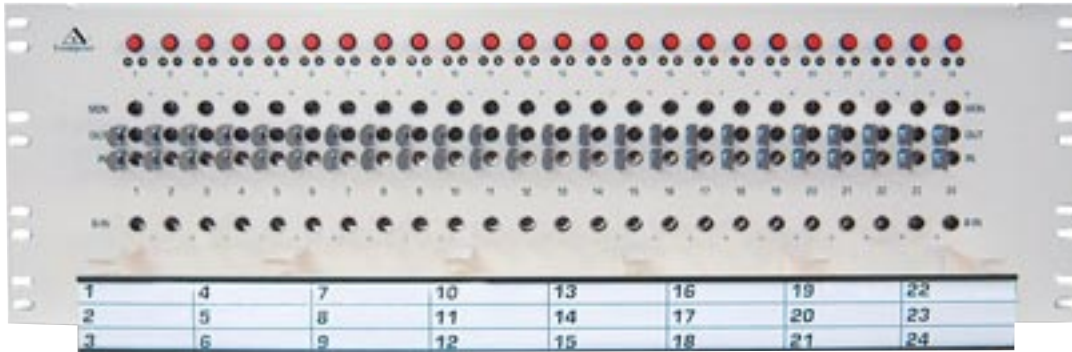

Verizon CCP System SSI #	SSI ST/ NS	Verizon CCP System PID #	PID ST/ NS	STARS Verizon West ID#	ID# ST/ DR	UoM	SHIP INT DAYS	TROMPETER Part Number	Verizon Description of Product	SHIP WEIGHT (lbs.)
<b>Front Cross Connect Bays - loaded</b>										
		001393339		914335		EA	7	PBTDSX3F4/24L-2	DSX3 BAY 23" W/9 JSTD3F4/24L-2 PANELS RTCLP	
001393339	NS	001393339		914336		EA	21	PBTDSX3F4/24L-4	DSX3 7" BAY 23" W/9 JSTD3F4/24L-4 PANELS LFCLP (To Replace PBTDSX-2)	350 .00
				914337		EA	7	PBTDSX3F4/32-2	DSX3 BAY 23" W/9 JSTD3F4/32-2 PANELS RTCLP	
				914338		EA	7	PBTDSX3F4/32-4	DSX3 BAY 23" W/9 JSTD3F4/32-4 PANELS LFCLP (CLEI CODE TMBXJOARA)	
<b>Front Cross Connect Panels - loaded</b>										
				914318		EA	7	JSTD3F4/24L-2	DSX3 PANEL 23" W/24 MWECO"FRNT"MODS RTCLP	
700248090	NS	001338557	NS	914319		EA	14	JSTD3F4/24L-4	DSX3 PANEL 23" W/24 MWECO"FRNT"MODS LFCLP (To Replace JSTD3F4-2)	16 .00
				914320		EA	7	JSTD3F4/32-2	DSX3 PANEL 23" W/32 MWECO"FRNT"MODS RTCLP (CLEI CODE T3MYAH9RAA)	
700248066	NS	001210665	NS	914321		EA	14	JSTD3F4/32-4	DSX3 PANEL 23" W/32 MWECO"FRNT"MODS LFCLP (To Replace 155-0944-1) (CLEI CODE T3MYAJARAA)	25 .00
		000156214				EA	25	155-0972-1	Mini DSX for customer premise, 3 circuits, w/ cords, 19"/23"	
<b>Cross Connect Modules - spares</b>										
700248125	NS	000071449	NS	914432		EA	14	TDSX3F4	MODULE 4 PORT FRONT (AUTO LOOPBACK) Replaces TDSX-3	0 .50
NOTES: OEM CODE = TMPR      PRODUCT CLASS = 131002										



# Front & Rear Module Views

Verizon Approved Trompeter Products For DS3 Applications (NP-IL-2001-107)



**NEBS LEVEL 3 TYPE 2 COMPLIANT  
AND TEST CERTIFIED**

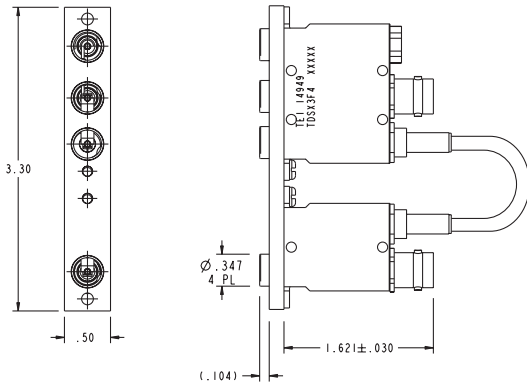

CIRCUIT SCHEMATIC

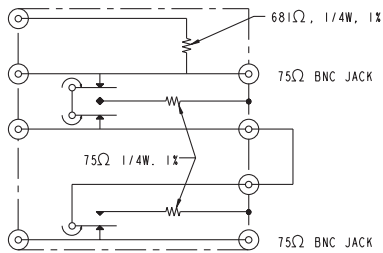

**Front Cross Connect Module: TDSX3F4**  
The Trompeter DS3 front cross connect bay (PBTDSX3F4/24) uses 216 modules of TDSX3F4 cross connect modules with auto loopback.

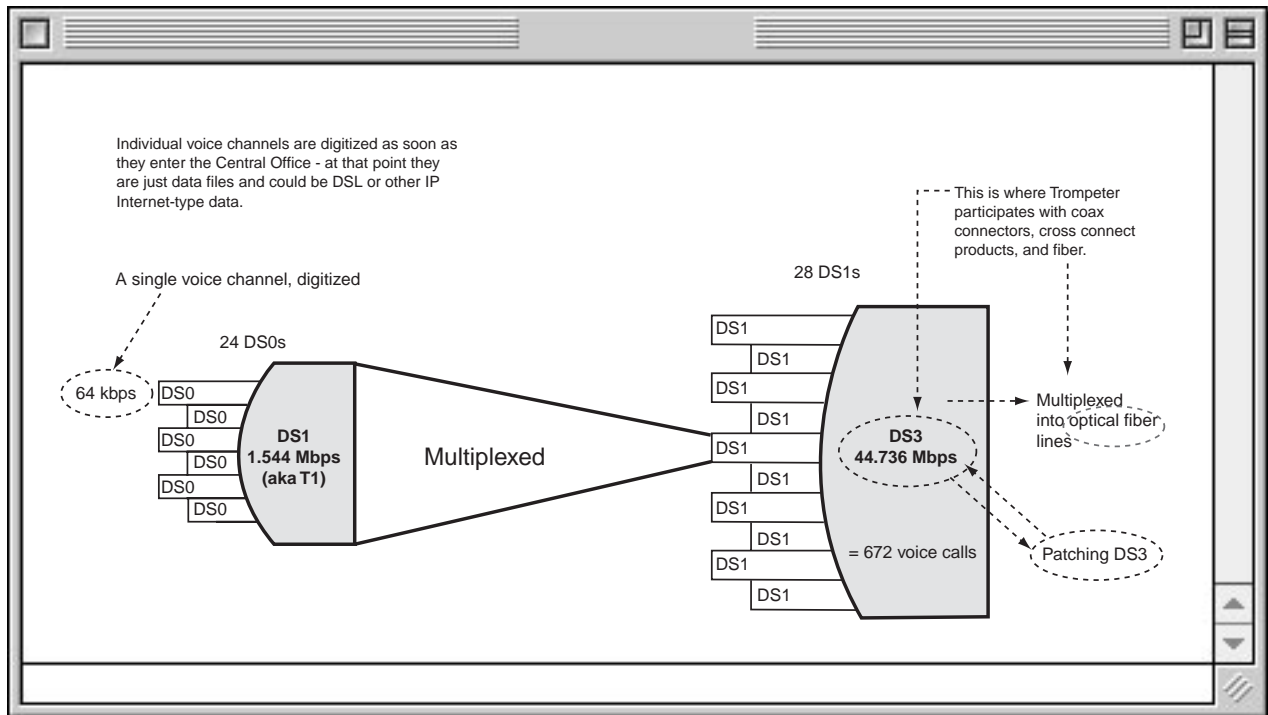



# 48 Position TIE-Panel For Multiple Front Cross Connect Line-Ups

Verizon Approved Trompeter Products For DS3 Applications (NP-IL-2001-107)



**NEBS LEVEL 3 TYPE 2 COMPLIANT  
AND TEST CERTIFIED**

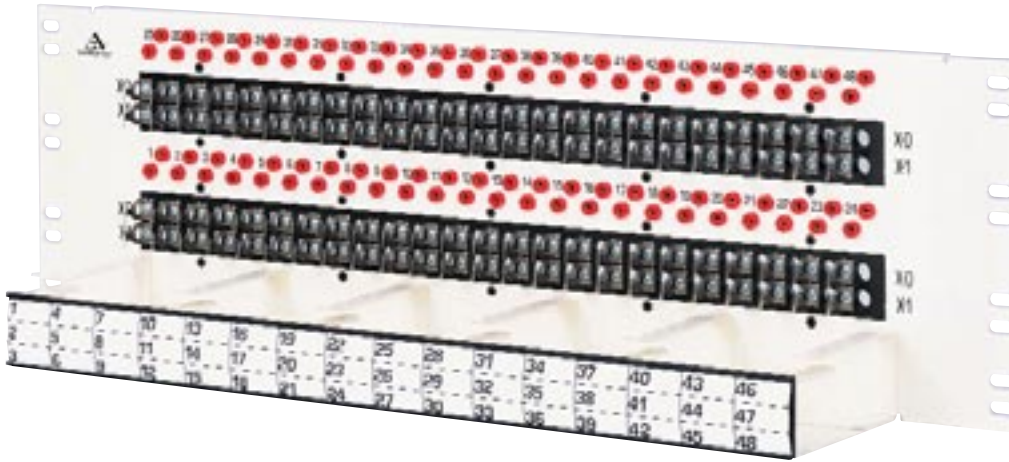

Module face plate available with and without lateral tabs, depending on spacing and number of modules per panel.

Verizon	SSI	Verizon	PID	STARS	ID#	SHIP	TROMPETER	
CCP System	ST/	CCP System	ST	Verizon	ST/	UoM	Part Number	Verizon Description of Product
SSI #	NS	PID #	NS	West ID#	DR	DAYS		
				914329		EA 7	JSTDSX-TIE	Panel TIE W/48 DSX-3 Circuits (CLEI CODE T3MYAHR)
						EA 21	JSTDSX-TIE/64	Panel TIE W/64 DSX-3 Circuits
NOTES: OEM CODE = TMPR      PRODUCT CLASS = 131002								

## JSTDSX TIE Panels

p/n **JSTDSX-TIE**

TIE panels are used to join multiple lineups or frames of cross connects allowing very flexible management and control of the DS3 coaxial wireline in a larger telco central office.

### Features:

- 2 Rows of 24 DS3 single IN/OUT circuits in one panel, Mini-WECO jack to BNC jack
- Integral cable management shelf is identical in form, fit and function to the JSTDSX3F4/24 panel
- Accepts standard Mini-WECO 440 patch cords with locking clips on left side of part facing panel.
- Cross connect tracer circuits for all DSX modules
- Rear monitoring available when used in conjunction with monitor assembly p/n:105-1497-1.
- Also available in 32 position configurations in a 23 inch panel (p/n: **JSTDSX-TIE/32**)



# Unloaded Panels, Unloaded Bays, & Bay Accessories

Verizon Approved Trompeter Products For DS3 Applications (NP-IL-2001-107)



**NEBS LEVEL 3 TYPE 2 COMPLIANT  
AND TEST CERTIFIED**

Verizon CCP System SSI #	Verizon ST/ NS	Verizon CCP System PID #	PID NS	STARS Verizon West ID#	ID# DR	SHIP UoM	SHIP INT DAYS	TROMPETER Part Number	Verizon Description of Product	SHIP WEIGHT (lbs.)
<b>Optional Bay Accessories</b>										
				914272	EA	24		150-0144	BAY NETWORK EXTENDER GUARD SPACER KIT (DSX TYPE = Both)	
				914273	EA	24		150-0145	BAY BOTTOM SPACER (DSX TYPE = Both)	
				914274	EA	24		150-0146-24	BAY 24" NETWORK EXTENDER (DSX TYPE = Both)	
				914275	EA	24		150-0146-54	BAY 54" NETWORK EXTENDER (DSX TYPE = Both)	
				914276	EA	24		150-0147-2	BAY 2.5" NETWORK SPACER (DSX TYPE = Both)	
				914277	EA	24		150-0147-5-84	BAY 5" NETWORK EXTENDER (DSX TYPE = Both)	
				914278	EA	24		150-0148	BAY NETWORK POWER STRIP (DSX TYPE = Both)	
				914270	EA	24		010-0171	TOOL EXTRACTION W/TIP (DSX TYPE = Both)	
				914271	EA	24		010-0171-101	TOOL EXTRACTION TIP ONLY (DSX TYPE = Both)	
				914333	EA	7		PBTDSX3F0/24L	BAY 23" BLANK UPTO 9 JSTD3F4/24 PANELS (DSX TYPE = Front)	
				914334	EA	7		PBTDSX3F0/32	BAY 23" BLANK UPTO 9 JSTD3F4/32 PANELS (DSX TYPE = Front)	
				914322	EA	7		JSTD3R0/24L	DSX3 PANEL 23" BLNK F/24 MINIWECO"REAR"MODS (DSX TYPE = Rear)	
				914324	EA	7		JSTD3R0/32	DSX3 PANEL 23" BLNK F/32 MINIWECO"REAR"MODS (DSX TYPE = Rear)	
				914314	EA	7		JSTD3F0/24L-2	DSX3 PANEL 23"BLNK F/24 MWECO"FR"MODS RTCLP (DSX TYPE = Front)	
700248089	NS	001338540	NS	914315	EA	14		JSTD3F0/24L-4	DSX3 PANEL 23"BLNK F/24 MWECO"FR"MODS LFCLP (To Replace JSTD3X-1) (DSX TYPE = Front)	3 .00
				914316	EA	7		JSTD3F0/32-2	DSX3 PANEL 23"BLNK F/32 MWECO"FR"MODS RTCLP (To Replace 155-0944-1) (DSX TYPE = Front)	
700248065	NS	000130659	NS	914317	EA	14		JSTD3F0/32-4	DSX3 PANEL 23"BLNK F/32 MWECO"FR"MODS LFCLP (DSX TYPE = Front)	
				914339	EA	10		PBTDSX3R0/24L	BAY 23"BLANK 10POS JSTD3R4ORR6/24 PNLS (DSX TYPE = Rear)	
				914340	EA	10		PBTDSX3R0/32	BAY 23"BLANK 10POS JSTD3R4ORR6/32 PNLS (DSX TYPE = Rear)	

NOTES: OEM CODE = TMPR PRODUCT CLASS = 131002

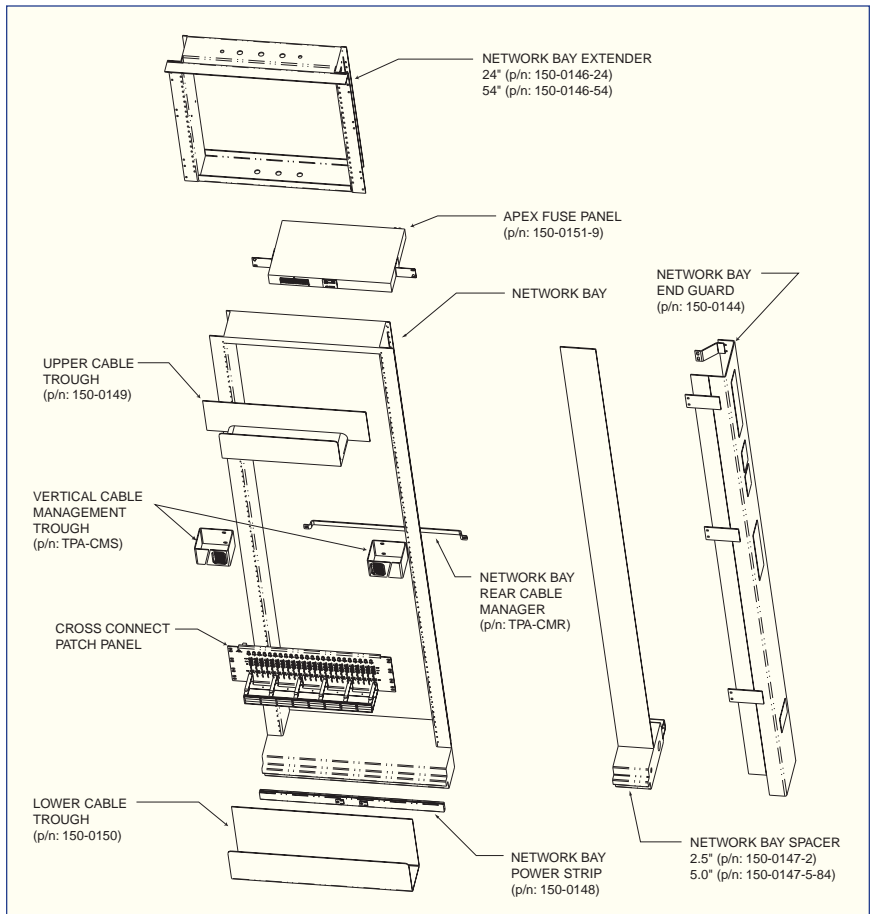
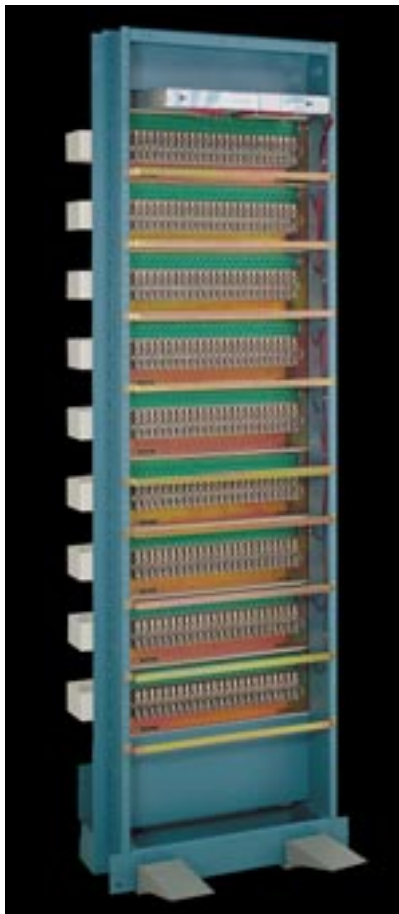

# Telco Co-Location POT (Meet-Me) Demarcation Panel & Standard Panel

Verizon Approved Trompeter Products For DS3 Applications (NP-IL-2001-107)



## Network POT "Meet Me" Panel

Verizon CCP System	SSI ST/	Verizon CCP System	PID ST	STARS Verizon	ID# ST/	SHIP UoM	TROMPETER Part Number	Verizon Description of Product	
SSI #	NS	PID #	NS	West ID#	DR	INT	DAYS		
								Co-Location Panel - loaded	
		000949164		914330		EA	5	JSCL-48CM	Co-lo panel 23" black with 48 BNC jack/jack adaptors w/Cable Mgt
700248064		001055730				EA	5	155-0899-1	Co-lo panel 23" gray with 48 BNC jack/jack adaptors
NOTES: OEM CODE = TMPR		PRODUCT CLASS = 131002							

## STANDARD DISTRIBUTION PANELS

Verizon CCP System	SSI ST/	Verizon CCP System	PID ST	STARS Verizon	ID# ST/	SHIP UoM	TROMPETER Part Number	Verizon Description of Product	SHIP WEIGHT (lbs.)	
SSI #	NS	PID #	NS	West ID#	DR	INT	DAYS			
								Distribution Panels		
700248064	NS	001055730	NS	TBD		EA	14	105-0899-1	Distribution Panel	3 .00
700248064	NS	00281170	NS	TBD		EA	14	JS-32D3SF7	Panel Assembly	2 .00
700248087	NS	000281196	NS	TBD		EA	14	JS32D3SF7/UBJ28	Panel Assembly Loaded	4 .00
700248088	NS	000949164	NS	TBD		EA	14	JS48D3SF7/UBJ28	Panel Assembly Loaded	4 .50
								Standard Panels		
				788983		EA		JSI-20	Insulated Patch Panel Assembly	
				720667		EA		JS-24W	Panel Assembly Jackfield	
				87266011		EA		JSI-12/J19	Insulated Patch Panel 12 Port Loaded RCA/N-50 Ohm	
NOTES: OEM CODE = TMPR		PRODUCT CLASS = 131002								



Verizon CCP System	SSI ST/	Verizon CCP System	PID ST	STARS Verizon	ID# ST/	SHIP UoM	TROMPETER Part Number	Verizon Description of Product	SHIP WEIGHT (lbs.)	
SSI #	NS	PID #	NS	West ID#	DR	INT	DAYS			
700254594		TBD		TBD				AD1WHD	Adapter Patch (Replaced AD1W)	0 .06
700248132	NS	000265025	NS	TBD		EA	14	UBJ28	Bulkhead Jack BNC 75 ohm	0 .06
700248132		000265025				EA	14	UBJ228	Bulkhead Mount feed-through 75 ohm BNC Adaoter	
700248133	NS	000265181	NS	TBD		EA	14	UCJ220-016	Tool Crimp BNC Cable Jack 75 Ohm	0 .05
700248134	NS	000265173	NS	TBD		EA	14	UCJ220-025	Tool Crimp BNC Cable Jack 75 Ohm	0 .05
700248135	NS	000265165	NS	TBD		EA	14	UCJ220-026	Tool Crimp BNC Cable Jack 75 Ohm	0 .05
700248136	NS	000330993	NS	TBD		EA	14	UCJ220-027	Tool Crimp BNC Cable Jack 75 Ohm	0 .05
700248130	NS	001337807	NS	332837	DR	EA	14	UADRMF220	Adapter BNC R/A right angle 75 ohm	0 .04
700248129	NS	000331009	NS	87249282	ST	EA	14	UAD28	Adapter BNC Jack/Jack 75 ohm	0 .05
700254599		TBD		TBD		EA	14	UADPL20	BNC Adapter 75 ohm	0 .06
700248128		000980813				EA	14	UTNAF1-1-75	75 ohm Termination Plug for BNC Cable Tester	
700248072	NS	000223529	NS	753150	DR	EA	14	ADMW12	Female BNC to WECO 440 Plug Adapter	0 .06
700248116		000218610				EA	5	PL1MW-025	MiniWECO 440D plug, 734A cable, gold barrel, entry bushing	
700248117		000200170				EA	5	PL1MW-026	MiniWECO 440D plug, 735A cable, gold barrel, entry bushing	
700248116	NS	000218610	NS	TBD		EA	14	PL11AC-025	Patching Plug	0 .06
700248117	NS	000200170	NS	361639	DR	EA	14	PL11AC-026	Patching Plug	0 .06
700248118	NS	999750268	NS	371954	DR	EA	14	PL11C-025	Patching Plug	0 .06
700248119	NS	000196873	NS	87005434	DR	EA	14	PL11C-026	Patching Plug	0 .06
700248091	NS	001337781	NS	TBD		EA	14	LCMWP-75	Looping Plug Cable Assy Mini-WECO 75 Ohm	0 .12
700248126	NS	001018050	NS	TBD		EA	14	TJMW-1-75	Mini-WECO Jack Terminated	0 .10
700248128	NS	000980813	NS	TBD		EA	14	TNAF1-1-75	Termination Plug 75 ohm	0 .10

NOTES: OEM CODE = TMPR PRODUCT CLASS = 131002

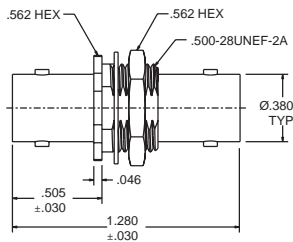

UBJ228

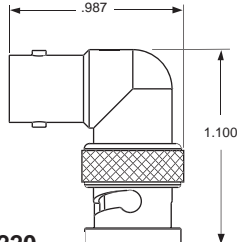

UADRMF220

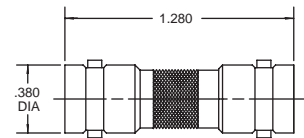

UAD28

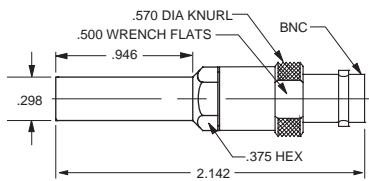

ADMW12

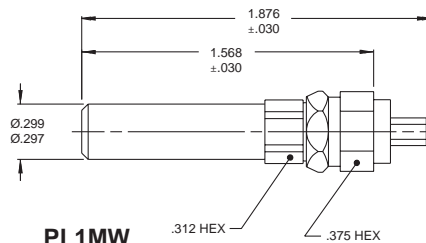

PL1MW

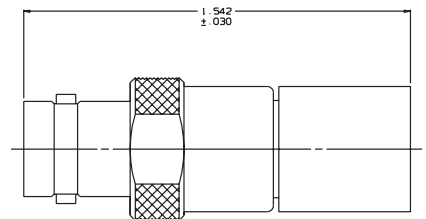

UTNAF1-1-75



# Mini-WECo to Mini-WECo Dual DS3 Patch Cords with Tracer Leads

Verizon Approved Trompeter Products For DS3 Applications (NP-IL-2001-107)



**NEBS LEVEL 3 TYPE 2 COMPLIANT  
AND TEST CERTIFIED**

Verizon CCP System SSI #	SSI ST/ NS	Verizon CCP System PID #	PID ST NS	STARS Verizon West ID#	ID# ST/ DR	SHIP UoM DAYS	TROMPETER Part Number	Verizon Description of Product	SHIP WEIGHT (lbs.)
<b>DSX Cross Connect Patch Cords (dual miniWECo to miniWECo with tracer leads)</b>									
700248106	NS	000958918	NS	914408	DR EA	14	PCMWTL-D-36	PATCHCORD DSX-3DUALXCT MWECO W/TRC 3FT	0.75
700248109	NS	001096999	NS	914409	DR EA	14	PCMWTL-D-48	PATCHCORD DSX-3DUALXCT MWECO W/TRC 4FT	1.00
700248113	NS	000958926	NS	914410	DR EA	14	PCMWTL-D-72	PATCHCORD DSX-3DUALXCT MWECO W/TRC 6FT	1.50
700248114	NS	001283753	NS	914411	DR EA	14	PCMWTL-D-84	PATCHCORD DSX-3DUALXCT MWECO W/TRC 7FT	1.75
700248115	NS	000958934	NS	914412	DR EA	14	PCMWTL-D-96	PATCHCORD DSX-3DUALXCT MWECO W/TRC 8FT	2.00
700248092	NS	000966481	NS	914414	DR EA	14	PCMWTL-D-108	PATCHCORD DSX-3DUALXCT MWECO W/TRC 9FT	2.25
700248093	NS	000958942	NS	914413	DR EA	14	PCMWTL-D-120	PATCHCORD DSX-3DUALXCT MWECO W/TRC 10FT	2.50
700248094	NS	001283761	NS	914415	DR EA	14	PCMWTL-D-132	PATCHCORD DSX-3DUALXCT MWECO W/TRC 11FT	2.75
700248095	NS	000966499	NS	914416	DR EA	14	PCMWTL-D-144	PATCHCORD DSX-3DUALXCT MWECO W/TRC 12FT	3.00
700248096	NS	001271105	NS	914417	DR EA	14	PCMWTL-D-156	PATCHCORD DSX-3DUALXCT MWECO W/TRC 13FT	3.25
700248097	NS	001078435	NS	914418	DR EA	14	PCMWTL-D-168	PATCHCORD DSX-3DUALXCT MWECO W/TRC 14FT	3.50
700248098	NS	000966549	NS	914419	DR EA	14	PCMWTL-D-180	PATCHCORD DSX-3DUALXCT MWECO W/TRC 15FT	3.75
700248099	NS	001078443	NS	914420	DR EA	14	PCMWTL-D-192	PATCHCORD DSX-3DUALXCT MWECO W/TRC 16FT	4.00
700248100	NS	001078450	NS	914421	DR EA	14	PCMWTL-D-216	PATCHCORD DSX-3DUALXCT MWECO W/TRC 18FT	4.50
700248101	NS	001271121	NS	914422	DR EA	14	PCMWTL-D-240	PATCHCORD DSX-3DUALXCT MWECO W/TRC 20FT	5.00
700248102	NS	001026822	NS	914423	DR EA	14	PCMWTL-D-264	PATCHCORD DSX-3DUALXCT MWECO W/TRC 22FT	5.50
700248103	NS	001271147	NS	914424	DR EA	14	PCMWTL-D-276	PATCHCORD DSX-3DUALXCT MWECO W/TRC 23FT	5.75
700248104	NS	000966564	NS	914425	DR EA	14	PCMWTL-D-300	PATCHCORD DSX-3DUALXCT MWECO W/TRC 25FT	6.25
700248105	NS	001026830	NS	914426	DR EA	14	PCMWTL-D-324	PATCHCORD DSX-3DUALXCT MWECO W/TRC 27FT	6.75
700248107	NS	000959924	NS	914427	DR EA	14	PCMWTL-D-360	PATCHCORD DSX-3DUALXCT MWECO W/TRC 30FT	7.50
700248108	NS	000959908	NS	914428	DR EA	14	PCMWTL-D-420	PATCHCORD DSX-3DUALXCT MWECO W/TRC 35FT	8.75
700248110	NS	000959841	NS	914429	DR EA	14	PCMWTL-D-480	PATCHCORD DSX-3DUALXCT MWECO W/TRC 40FT	10.00
700248111	NS	000959783	NS	914430	DR EA	14	PCMWTL-D-540	PATCHCORD DSX-3DUALXCT MWECO W/TRC 45FT	11.25
700248112	NS	000959668	NS	914431	DR EA	14	PCMWTL-D-600	PATCHCORD DSX-3DUALXCT MWECO W/TRC 50FT	12.50
<b>Patch Cords WECo Cable Assembly</b>									
700254596		TBD		TBD	EA	14	PCW-96-75BLU	PATCHCORD WECo PL1WC-TCC-765-2/PL1WC BLUE, 8FT	1.00
700254597		TBD		TBD	EA	14	PCW-96-75RED	PATCHCORD WECo PL1WC-TCC-765-2/PL1WC RED, 8FT	1.00

NOTES: OEM CODE = TMPR      PRODUCT CLASS = 131002

Trompeter Telco Standard Dual Patch Cord,  
Mini-WECo Plugs with Tracer Wire.

**PCMWTL-D-(inches):**

**Patch Cord, Mini-WECo Plugs, Tracer  
Wire - Dual - Inches**

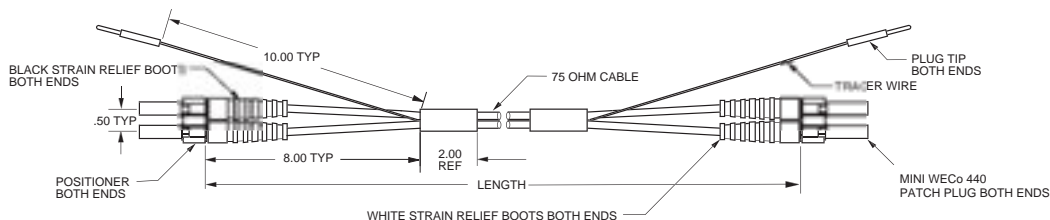

# BNC to BNC Dual DS3 Cable Assemblies with Tracer Leads

Verizon Approved Trompeter Products For DS3 Applications (NP-IL-2001-107)



Trompeter Telco Standard Cable Assemblies  
BNC Plugs with Tracer Wire.

**PCBTL-D-(inches):**

**Cable Assembly, BNC Plugs, Tracer Wire - Dual - Inches**

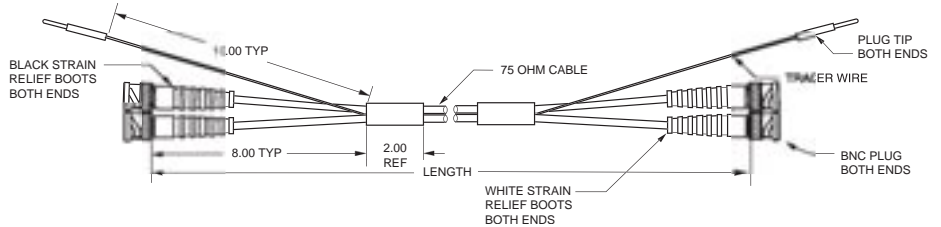

Verizon CCP System SSI #	SSI ST/ NS	Verizon CCP System PID #	PID ST NS	STARS Verizon West ID#	ID# ST/ DR	SHIP UoM DR	SHIP INT DAYS	TROMPETER Part Number	Verizon Description of Product
<b>Rear DSX Cable Assemblies (dual BNC to BNC with tracer leads)</b>									
				914345	EA	7		<b>PCBTL-D-24</b>	PATCHCORD DSX-3DUALXCTW/BNCS&TRCR 2FT
				914346	EA	7		<b>PCBTL-D-36</b>	PATCHCORD DSX-3DUALXCTW/BNCS&TRCR 3FT
				914347	EA	7		<b>PCBTL-D-48</b>	PATCHCORD DSX-3DUALXCTW/BNCS&TRCR 4FT
				914348	EA	7		<b>PCBTL-D-60</b>	PATCHCORD DSX-3DUALXCTW/BNCS&TRCR 5FT
				914349	EA	7		<b>PCBTL-D-72</b>	PATCHCORD DSX-3DUALXCTW/BNCS&TRCR 6FT
				914350	EA	7		<b>PCBTL-D-84</b>	PATCHCORD DSX-3DUALXCTW/BNCS&TRCR 7FT
				914351	EA	7		<b>PCBTL-D-96</b>	PATCHCORD DSX-3DUALXCTW/BNCS&TRCR 8FT
				914352	EA	7		<b>PCBTL-D-108</b>	PATCHCORD DSX-3DUALXCTW/BNCS&TRCR 9FT
				914353	EA	7		<b>PCBTL-D-120</b>	PATCHCORD DSX-3DUALXCTW/BNCS&TRCR 10FT
				914354	EA	7		<b>PCBTL-D-132</b>	PATCHCORD DSX-3DUALXCTW/BNCS&TRCR 11FT
				914367	EA	7		<b>PCBTL-D-144</b>	PATCHCORD DSX-3DUALXCTW/BNCS&TRCR 12FT
				914368	EA	7		<b>PCBTL-D-156</b>	PATCHCORD DSX-3DUALXCTW/BNCS&TRCR 13FT
				914369	EA	7		<b>PCBTL-D-168</b>	PATCHCORD DSX-3DUALXCTW/BNCS&TRCR 14FT
				914370	EA	7		<b>PCBTL-D-180</b>	PATCHCORD DSX-3DUALXCTW/BNCS&TRCR 15FT
				914371	EA	7		<b>PCBTL-D-192</b>	PATCHCORD DSX-3DUALXCTW/BNCS&TRCR 16FT
				914372	EA	7		<b>PCBTL-D-204</b>	PATCHCORD DSX-3DUALXCTW/BNCS&TRCR 17FT
				914373	EA	7		<b>PCBTL-D-216</b>	PATCHCORD DSX-3DUALXCTW/BNCS&TRCR 18FT
				914374	EA	7		<b>PCBTL-D-228</b>	PATCHCORD DSX-3DUALXCTW/BNCS&TRCR 19FT
				914375	EA	7		<b>PCBTL-D-240</b>	PATCHCORD DSX-3DUALXCTW/BNCS&TRCR 20FT
				914376	EA	7		<b>PCBTL-D-252</b>	PATCHCORD DSX-3DUALXCTW/BNCS&TRCR 21FT
				914377	EA	7		<b>PCBTL-D-264</b>	PATCHCORD DSX-3DUALXCTW/BNCS&TRCR 22FT
				914378	EA	7		<b>PCBTL-D-276</b>	PATCHCORD DSX-3DUALXCTW/BNCS&TRCR 23FT
				914379	EA	7		<b>PCBTL-D-288</b>	PATCHCORD DSX-3DUALXCTW/BNCS&TRCR 24FT
				914380	EA	7		<b>PCBTL-D-300</b>	PATCHCORD DSX-3DUALXCTW/BNCS&TRCR 25FT
				914381	EA	7		<b>PCBTL-D-312</b>	PATCHCORD DSX-3DUALXCTW/BNCS&TRCR 26FT
				914382	EA	7		<b>PCBTL-D-324</b>	PATCHCORD DSX-3DUALXCTW/BNCS&TRCR 27FT
				914383	EA	7		<b>PCBTL-D-336</b>	PATCHCORD DSX-3DUALXCTW/BNCS&TRCR 28FT
				914385	EA	7		<b>PCBTL-D-348</b>	PATCHCORD DSX-3DUALXCTW/BNCS&TRCR 29FT
				914386	EA	7		<b>PCBTL-D-360</b>	PATCHCORD DSX-3DUALXCTW/BNCS&TRCR 30FT
				914387	EA	7		<b>PCBTL-D-372</b>	PATCHCORD DSX-3DUALXCTW/BNCS&TRCR 31FT
				914388	EA	7		<b>PCBTL-D-384</b>	PATCHCORD DSX-3DUALXCTW/BNCS&TRCR 32FT
				914389	EA	7		<b>PCBTL-D-396</b>	PATCHCORD DSX-3DUALXCTW/BNCS&TRCR 33FT
				914390	EA	7		<b>PCBTL-D-408</b>	PATCHCORD DSX-3DUALXCTW/BNCS&TRCR 34FT
				914391	EA	7		<b>PCBTL-D-420</b>	PATCHCORD DSX-3DUALXCTW/BNCS&TRCR 35FT
				914392	EA	7		<b>PCBTL-D-432</b>	PATCHCORD DSX-3DUALXCTW/BNCS&TRCR 36FT
				914393	EA	7		<b>PCBTL-D-444</b>	PATCHCORD DSX-3DUALXCTW/BNCS&TRCR 37FT
				914394	EA	7		<b>PCBTL-D-456</b>	PATCHCORD DSX-3DUALXCTW/BNCS&TRCR 38FT
				914395	EA	7		<b>PCBTL-D-468</b>	PATCHCORD DSX-3DUALXCTW/BNCS&TRCR 39FT
				914396	EA	7		<b>PCBTL-D-480</b>	PATCHCORD DSX-3DUALXCTW/BNCS&TRCR 40FT
				914397	EA	7		<b>PCBTL-D-492</b>	PATCHCORD DSX-3DUALXCTW/BNCS&TRCR 41FT
				914398	EA	7		<b>PCBTL-D-504</b>	PATCHCORD DSX-3DUALXCTW/BNCS&TRCR 42FT
				914399	EA	7		<b>PCBTL-D-516</b>	PATCHCORD DSX-3DUALXCTW/BNCS&TRCR 43FT
				914400	EA	7		<b>PCBTL-D-528</b>	PATCHCORD DSX-3DUALXCTW/BNCS&TRCR 44FT
				914401	EA	7		<b>PCBTL-D-540</b>	PATCHCORD DSX-3DUALXCTW/BNCS&TRCR 45FT
				914402	EA	7		<b>PCBTL-D-552</b>	PATCHCORD DSX-3DUALXCTW/BNCS&TRCR 46FT
				914403	EA	7		<b>PCBTL-D-564</b>	PATCHCORD DSX-3DUALXCTW/BNCS&TRCR 47FT
				914404	EA	7		<b>PCBTL-D-576</b>	PATCHCORD DSX-3DUALXCTW/BNCS&TRCR 48FT
				914405	EA	7		<b>PCBTL-D-588</b>	PATCHCORD DSX-3DUALXCTW/BNCS&TRCR 49FT
				914406	EA	7		<b>PCBTL-D-600</b>	PATCHCORD DSX-3DUALXCTW/BNCS&TRCR 50FT

NOTES: OEM CODE = TMPR PRODUCT CLASS = 131002



# Trompeter Telco Carrier Class DS3 BNC Connector

Verizon Approved Trompeter Products For DS3 Applications (NP-IL-2001-107)



**NEBS LEVEL 3 TYPE 2 COMPLIANT  
AND TEST CERTIFIED**

**All True 75 Ohm  
Carrier Class  
Connectors**

Verizon CCP System SSI #	SSI ST/ NS	Verizon CCP System PID #	PID ST NS	STARS Verizon West ID#	ID# ST/ DR	SHIP UoM DAYS	TROMPETER Part Number	Verizon Description of Product	SHIP WEIGHT (lbs.)
700254600		TBD		583860	DR	EA 14	UPL220-009	Connector Plug BNC Straight 75 ohm	0.03
700254601		TBD		882892 & 501570	EA	EA 14	UPL220-013	Connector Plug BNC Straight 75 ohm	0.06
700254602		TBD		885886	ST	EA 14	UPL220-014	Connector Plug BNC Straight 75 ohm	0.06
700248137	NS	999796162	NS	753798	DR	EA 14	UPL220-016	Connector Plug BNC Straight 75 ohm	0.03
700254622		TBD		TBD		EA 14	UPL220-020	Connector Plug BNC Straight 75 ohm	0.03
700248138	NS	999691520	ST	357138	ST	EA 14	UPL220-025	Connector Plug BNC Straight 734A Cable 75 ohm	0.03
700254603		000143043		87286399	DR	EA 14	UPL220-025/T50	Connector Plug BNC Straight 734A Cable Bulk Pack of 50, 75 ohm	1.13
700248139	NS	999828742	ST	356925	ST	EA 14	UPL220-026	Connector Plug BNC Straight 735A Cable 75 ohm	0.03
700254604		000143044		87264874	DR	EA 14	UPL220-026/T50	Connector Plug BNC Straight 735A Cable Bulk Pack of 50, 75 ohm	1.14
700248140	NS	000265199	NS	325781	DR	EA 14	UPL220-027	Connector Plug BNC Straight 75 ohm	0.05
700254588		TBD		TBD		EA 14	105-1215-9	Connector Plug BNC Straight 75 ohm	0.03
700254605		TBD		339555	DR	EA 14	UPL240-027	Connector Plug TNC Straight 75 ohm	0.03
700254606		TBD		360402		EA 14	UPL240-026	Connector Plug TNC Straight 75 ohm	0.03
700254607		TBD		325562	ST	EA 14	UPL240-027	Connector Plug TNC Straight 75 ohm	0.03
700254589		TBD		323782	ST	EA 14	105-1215-10	Connector Plug TNC 75-ohm F/Belden YR23023	0.03
700254592		TBD		TBD		EA 14	105-1244-9	Connector Plug BNC Straight 75 ohm	0.03
700248063	NS	001337765	NS	501595	DR	EA 14	105-1541-9	Connector Plug BNC Straight 75 ohm	0.50
700254608		TBD		TBD		EA 14	UPL250-025	Connector Mini-BNC Plug Straight 75 ohm	0.03
700254609		TBD		TBD		EA 14	UPL250-026	Connector Mini-BNC Plug Straight 75 ohm	0.03
700248141	NS	001337799	NS	501580	DR	EA 14	UPLFF220-016	Connector Plug BNC 45 Degree 75 ohm	0.05
700248142	NS	000970301	NS	501581	DR	EA 14	UPLFF220-025	Connector Plug BNC 45 Degree 734A Cable 75 ohm	0.05
700248143	NS	000970293	NS	501582	DR	EA 14	UPLFF220-026	Connector Plug BNC 45 Degree 735A Cable 75 ohm	0.05
700254591		TBD		TBD		EA 14	105-1244-20	Connector Plug BNC 45 Degree 75 ohm	0.06
700254623		TBD		501573		EA 14	UPLR220-009	Connector Plug BNC Right Angle 75 ohm	0.06
700248144	NS	998919096	ST	501572	DR	EA 14	UPLR220-016	Connector Plug BNC Right Angle 75 ohm	0.06
700248145	NS	999823784	ST	352781	ST	EA 3	UPLR220-025	Connector Plug BNC Right Angle 734A Cable 75 ohm	0.06
700254610		TBD		TBD		EA 14	UPLR220-025/T25	Connector Plug BNC Right Angle 735A Cable Bulk Pack of 25, 75 ohm	1.46
700254611		TBD		TBD		EA 14	UPLR220-025/T50	Connector Plug BNC Right Angle 735A Cable Bulk Pack of 50, 75 ohm	2.69
700248146	NS	000195800	ST	361126	ST	EA 14	UPLR220-026	Connector Plug BNC Right Angle 735A Cable 75 ohm	0.06
700254612		TBD		87263603		EA 14	UPLR220-026/T25	Connector Plug BNC Right Angle 735A Cable Bulk Pack of 25, 75 ohm	1.46
700254613		TBD		TBD		EA 14	UPLR220-026/T50	Connector Plug BNC Right Angle 735A Cable Bulk Pack of 50, 75 ohm	2.69
700254590		TBD		TBD		EA 14	105-1244-19	Connector Plug BNC Right Angle 75 ohm	0.06
700248071	NS	000331058	NS	TBD		EA 14	805-1185-5-10	Extra BNC Center Contacts For 734A Cable (Bag of 10)	0.05
700248070	NS	000331074	NS	TBD		EA 14	805-1185-2-10	Extra BNC Center Contacts For 735A Cable (Bag of 10)	0.05
700254593		TBD		87288774	DR	EA 14	805-1911-12-5G	Extra BNC Center Contacts For UPL220-025 (734 Cable) Bag of 10	0.01
700248068	NS	000331025	NS	TBD		EA 14	8-1613-16-10	Extra BNC Crimp Sleeves for 734A (Bag of 10)	0.05
700248069	NS	000331033	NS	TBD		EA 14	8-1613-26-10	Extra BNC Crimp Sleeves for 735A (Bag of 10)	0.05

NOTES: OEM CODE = TMPR PRODUCT CLASS = 131002

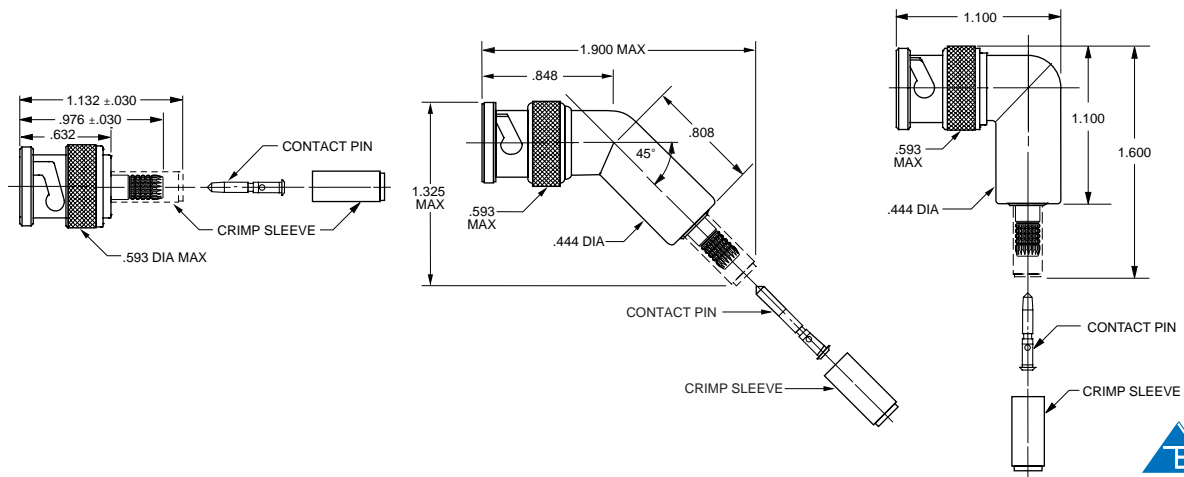

# Installation Tools for Telco Carrier Class DS3 Connectors

Verizon Approved Trompeter Products For DS3 Applications (NP-IL-2001-107)



Verizon CCP System SSI #	Verizon ST/ NS	Verizon CCP System PID #	Verizon ST/ NS	Verizon West ID#	ID# DR	UoM	SHIP INT DAYS	TROMPETER Part Number	Verizon Description of Product	SHIP WEIGHT (lbs.)
700248067	NS	000222497	NS	TBD		EA	14	<b>700-0024</b>	Cable cutter (coaxial)	0 .81
700248123	NS	000164020	NS	589323	DR EA	EA	14	<b>ST1/STC-F</b>	Tool - cable stripper with blade cassette for 734/735 cable	0 .09
700248124	NS	000274407	NS	589313	DR EA	EA	14	<b>STC-F</b>	Tool - blade cassette for ST1 strip tool	0 .03
700248122	NS	999719909	NS	339917	DR EA	EA	14	<b>ST1</b>	Tool Stripping Manual Coax Cable (tool only-no blades)	0 .72
700248127	NS	000151035	NS	339919	DR EA	EA	14	<b>TK2-17</b>	BNC Crimp Tool kit includes stripping and crimping tools	5 .25
700248057	NS	000222877	NS	339918	DR EA	EA	14	<b>010-0061-1</b>	Assembly Tool Box - spare red box only	0 .5
700248060	NS	000222539	NS	TBD		EA	14	<b>010-0090</b>	Tool kit - telco tool kit - loaded except for power stripper	6 .00
700248085	NS	999952369	NS	87261116	DR EA	EA	4	<b>CT4L</b>	Tool - Crimp tool for Connector Crimp Sleeve (Replaces CT3)	1 .19
700254595		TBD		87286974	DR EA	EA	14	<b>CT4L/CD3-19</b>	Tool - BNC Crimp Tool/ Flip Flop Die 734/735	1 .23
700248082	NS	000134205	NS	589310	DR EA	EA	14	<b>CD3-1</b>	Tool - Crimp Die for 735 BNC Sleeve	0 .03
700248084	NS	999949456	NS	574534	DR EA	EA	14	<b>CD3-2</b>	Tool - Crimp Die for 734 BNC Sleeve	0 .03
700248083	NS	000222547	NS	87231512	DR EA	EA	14	<b>CD3-19</b>	Tool - "FLIP-FLOP" crimp die for 734/735 BNC & WECO 440 Connectors (inserts into CT4L tool). Customizing available.	0 .03
700254587		TBD		87062646	DR EA	EA	14	<b>010-0098</b>	Tool - Center contact 12 point indenter for both BNC and miniWECO connectors	1 .13
700248058	NS	000222653	NS	TBD		EA	14	<b>010-0070</b>	Tool - Tool Crimp 12 point for PL11AC Plug	1 .13
700248059	NS	000222414	NS	87225067	DR EA	EA	14	<b>010-0080</b>	Tool - Center contact 12 point indenter for just BNC connector.	1 .13
700248056	NS	000056986	NS	501721	DR EA	EA	14	<b>010-0055</b>	Tool - Center contact 8 point 734/735 for BNC (Red handle tool)	1 .13
700248081	NS	000222851	NS	87254355	DR EA	EA	14	<b>C26T3I</b>	Tool - cutter head for 735A cable, used in power cable strippers	0 .50
700248080	NS	000222810	NS	87254356	DR EA	EA	14	<b>C26T3D</b>	Tool - cutter head for 734A cable, used in power cable strippers	0 .50
700248078	NS	000222661	NS	TBD		EA	14	<b>C26T380634I</b>	Tool - cutter head	0 .75
700248079	NS	000222687	NS	TBD		EA	14	<b>C26T380634D</b>	Tool - cutter head	0 .75
700248075	NS	000222463	NS	TBD		EA	14	<b>BWS/C26T3I</b>	Tool - Battery operated cable stripper w/ 735A cutter head	4 .40
700248074	NS	000222455	NS	TBD		EA	14	<b>BWS/C26T3D</b>	Tool - Battery operated cable stripper w/734A cutter head	4 .40
700248073	NS	000222786	NS	TBD		EA	14	<b>BWS</b>	Tool - battery operated cable stripper, no cutter heads	4 .00
001393354	NS	001393354	NS	TBD		EA	14	<b>AWS</b>	Tool - AC power operated cable stripper, no cutter heads	12 .00
001393388	NS	001393388	NS	TBD		EA	14	<b>AWC-NSA</b>	Tool - AC Power converter for BWS cable strippers	8 .00
700248120	NS	000223511	NS	TBD		EA	14	<b>RBP-NSA</b>	Tool - spare battery for BWS coax strip tool	0 .75
700248121	NS	999949423	NS	578719	ST EA	EA	14	<b>RT1L</b>	Tool BNC Removal Insertion 12"	0 .01
700254598		TBD		TBD		EA	14	<b>RTR-1L</b>	Tool BNC Right Angle Removal Tool	0 .01
700248062	NS	001337773	NS	87273223	DR EA	EA	14	<b>010-0133</b>	Tester for BNC Continuity	0 .80
700248061	NS	00980805	NS	87266733	DR EA	EA	14	<b>010-0108</b>	Tester for BNC WECO Continuity	0 .90

NOTES: OEM CODE = **TMPR** PRODUCT CLASS = **131002**



Manual Cable Cutter  
**700-0024**



Center Contact 12 point Indentor  
**010-0098**



**010-0133**  
Coax Cable Assembly  
Connector Test Set  
75 Ohm BNC Plugs



Crimp Tool (only)  
**CT4L**

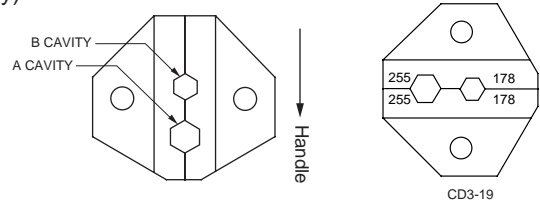

CRIMP DIES  
75 Ohm Outer Sleeve

	A	EMBOSES	B	EMBOSES
<b>CD3-19</b>	.178	178	.255	.255

\* Note: Dies imprint either cavity (A/B) or hex size onto crimp sleeve. Custom dies are available for special imprints.



BNC Removal Tool  
**RT1L** 12" in length





# Installation Tools for Telco Carrier Class DS3 Connectors

Verizon Approved Trompeter Products For DS3 Applications (NP-IL-2001-107)



## Tool Kit: 010-0090

1	STRIP CASSETTE (STC-F GREEN)
1	STRIPPING TOOL (ST1)
1	REMOVAL TOOL, LONG (RT1L)
1	CRIMPING TOOL, LONG (CT4L)
1	CABLE CUTTERS
1	BNC TESTER (ELECTRICAL)
1	CENTER CONTACT CRIMP TOOL
1	CRIMP DIE (CD3-2)
1	CRIMP DIE (CD3-19)
1	LABEL
1	CASE (2014A2973)
QTY	DESCRIPTION

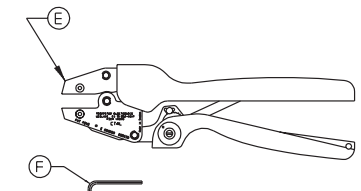
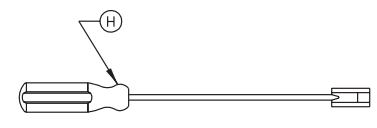
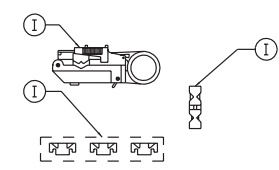
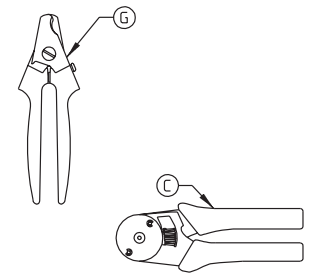
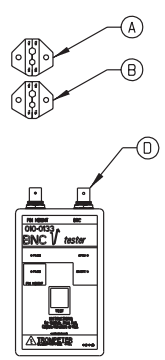
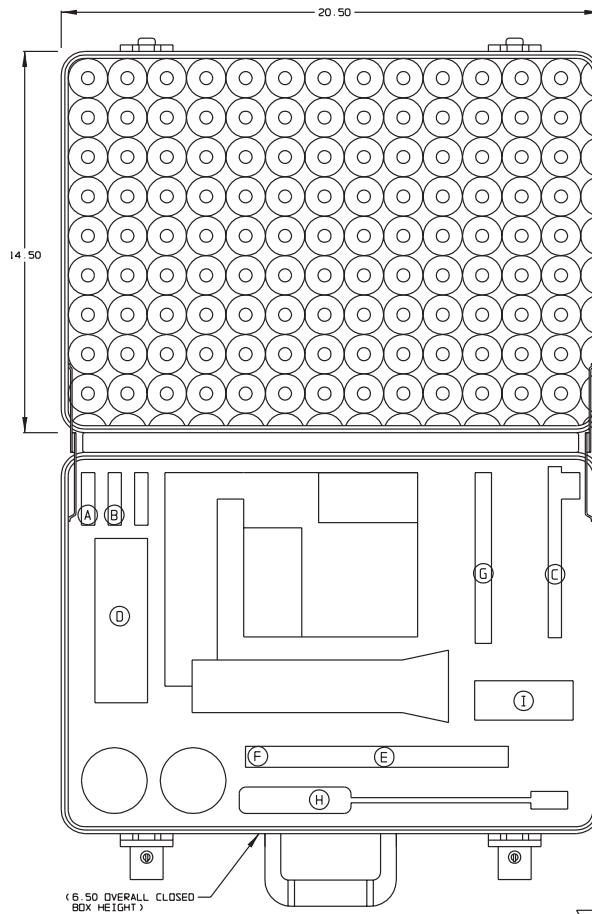

### POWERED CABLE STRIPPER KITS (Optional)

Comes with: 1 Drive, 1 Ni-Cad Battery Pak, 1 Cutter Head, 1 Rapid Charger/Reconditioner and 1 Carrying Case.

Part Number Example:

Stripper/Cutter Head

For Cables: 728 / 734A / RG-59 **BCWS/C26T3D**

For Cables: 735A / KS19224L2 **BCWS/C26T3I**



### POWERED CABLE STRIPPER



Picture Shown: Cable Stripper Unit (left), Driver (middle), Rapid Charger/Reconditioner (right).





# Installer Training for Telco Carrier Class DS3 Connectors

Verizon Approved Trompeter Products For DS3 Applications (NP-IL-2001-107)



## VERIZON INSTALLER TRAINING PROGRAM - Provided by Trompeter at no charge

### INSTALLER TRAINING

For over 30 years, Trompeter has been a leader in RF interconnect products for Telecom. We have developed a training program (a first of its kind) specifically for installers of Central Office.

### TELECOM APPLICATIONS

Utilization of coax cables and connectors has increased with the decision to utilize Hybrid Fiber/Coax platforms and the introduction of SONET, Frame Relay and ATM. Regional Bell Operating Companies have reported up to 33% of DS3 transmission failures are due to improper assembly of BNC/TNC interconnects. Our training is designed to accomplish the following:

- \* Reduce transmission noise
- \* Reduce system downtime in the field
- \* Increase installer productivity and the reliability/consistency of terminations.
- \* Lower installation costs

This course is customized to your application and covers correct cable preparation techniques, proper selection and use of tools, and high quality methodology for terminating cable assemblies. Each attendee receives training materials, certificate of completion as well as an I.D. card.

For additional information, contact your local Trompeter Sales Representative or contact our Technical Support Department at (800) 982-2629 and ask for Training Information Package.

Trompeter has also produced a 13 minute BNC Assembly Video and CD which outlines the major features of our BNC design, describes tools for reliable installation and gives step-by-step assembly instruction. The BNC Assembly Video and CD are available at no cost to all Verizon personnel. Instructions and this catalog are also available on CD.

